

WTT-4944 ***Parking Lot Controller***

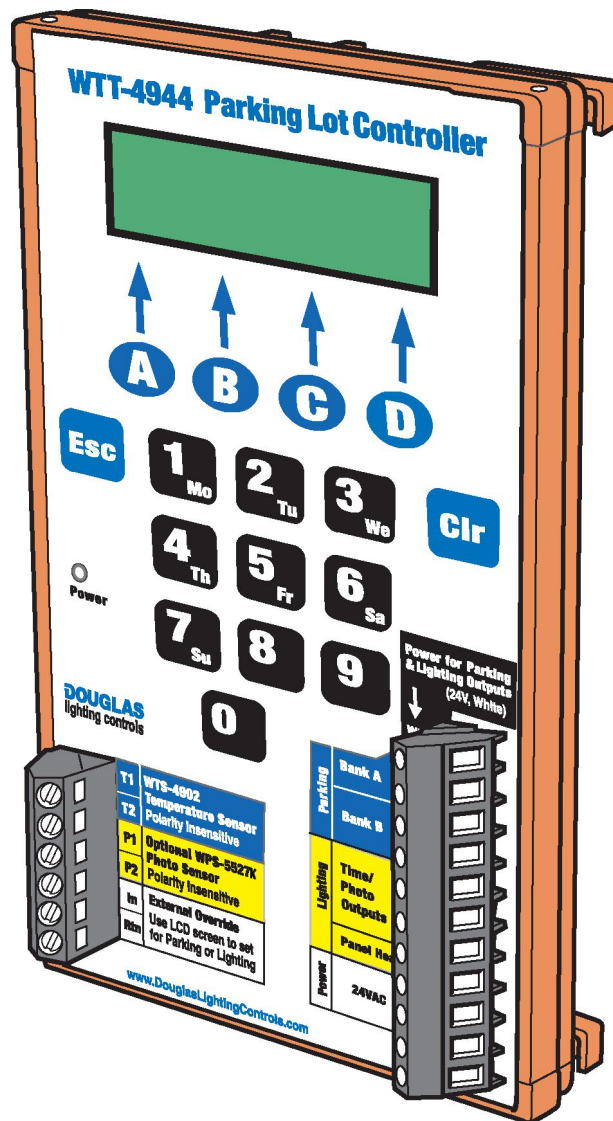

Instruction Manual

Contents

Introduction	1
Parts and Dimensions.....	2
Specifications	3
Installation.....	4
Main Menu	5
Setup Menu	6
Setup Menu: Date/Time, Daylight Savings	7
Setup Menu: Parking Settings.....	8
Setup Menu: Photo/Inputs/Clear Memory.....	10
Schedule Menu: Parking Outputs	11
Schedule Menu: Lighting Outputs	12
Schedule Menu: Examples	13
Manual Menu.....	14
Information Menu.....	15
Connections: Parking Lot Example	16
External Overrides	18
Troubleshooting.....	19
Appendix A -Parking Settings & Schedules	20
Appendix B -Lighting Schedules.....	21
Notes	22

WTT-4944 Parking Lot Controller

The WTT-4944 Parking Lot Controller switches Douglas relays connected to its outputs that control parking lot receptacle and lighting circuits. The Controller switches the relays in response to temperature, and optional daylight readings from sensor(s) connected to its inputs. You program how the Controller's responds using the LCD display and the membrane keypad.

WTT-4902 Temperature Sensor

- Mount outdoors.
- Connect to the T1/T2 unpolarized inputs with a twisted pair of unshielded 18-ga. wires.



WPS-5527K Photo Sensor (optional)

- Point to the Northern sky for best readings.
- Mount indoors or in a sheltered spot (such as under the relay panel).
- Connect to the unpolarized P1/P2 inputs with a twisted pair of unshielded 18-ga. wires.



External Override (optional)

Lighting Override (Option A)

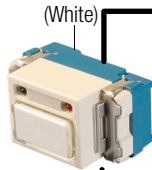

- WR-8501 LED switch can turn the lighting outputs ON or OFF.
- Must first be configured by selecting the LIGHTING input option with the SETUP Menu of the Controller.
- Connect to the White and to the INP input. Connect the RTN input to Blue. Use unshielded 18-ga. wires.

Parking Override (Option B)

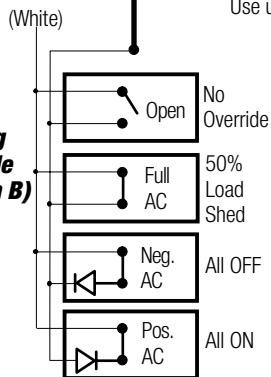

- Contact switches, which can be controlled by an Energy Management System (EMS), regulate the parking receptacle outputs as shown.
- Must first be configured by selecting the PARKING input option with the SETUP Menu of the Controller.
- Connect to the White and to the INP input. Connect the RTN input to Blue. Use unshielded 18-ga. wires.

Power Indicator

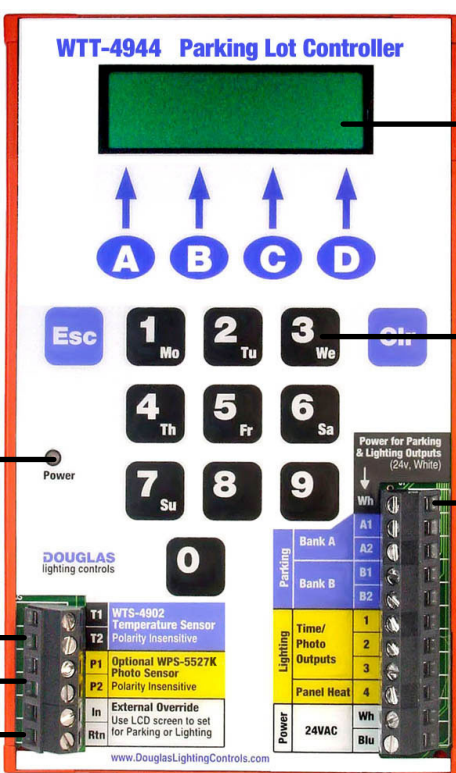

LCD Display

- When you are setting or programming the Controller, it displays prompts and results to guide you through the process.
- Normal display is current date/time, temperature and light level (when a WPS-5527 photo sensor is connected).

Membrane Keypad

- Use the number buttons to enter information when programming or setting the Controller.
- Use the CLR button to erase any unsaved information entered in the active LCD screen. Use the ESC button to return to the previous screen.

Outputs

- Connect outputs A1, A2, B1 and B2 to relays controlling parking lot receptacles.

Relays will be switched ON or OFF in response to temperature.

Maximum 4 relays per output. With more relays, use a relay scanner; maximum 4 relay scanners per output.

- Connect Outputs 1, 2 and 3 to the relays controlling lighting circuits.

Relays will be switched ON or OFF in response to time settings and/or light levels (when a WPS-5527 photo sensor is used).

Maximum 4 relays per output. With more relays, use a relay scanner; maximum 4 scanners per output.

- Connect Output 4 to the panel heater or, if a panel heater is not needed, to another lighting circuit.



Relay Scanners

- Each scanner controls up to 12 or 24 relays.



Relays

- Each relay switches the connected load ON or OFF.

Parts & Dimensions

WTT-4902 Temperature Sensor

- Connect to the T1/T2 inputs as shown.
- Must be installed outside.

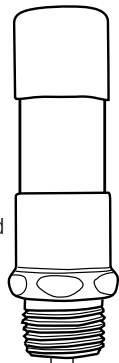

WPS-5527K Photo Sensor (optional)

- Connect to the P1/P2 inputs as shown.
- Point to the Northern sky for best exposure.



Sensor Inputs (4)

- Use two #18 AWG unshielded wires to connect each Sensor as shown. Inputs are polarity insensitive.

Override Inputs (2)

- Connect an override switch, or switches to INP and connect RTN to Blue. (Switches also connect to white).
- Override can be either of 2 options, as selected by the INPUT OPTIONS program command:

(a) LIGHTING Option

Remote switch can turn all the TIME/PHOTO Outputs ON or OFF.

(b) PARKING Option

Contact switches, usually controlled by an Energy Management System, can turn the PARKING Outputs ALL ON or ALL OFF as well as activate the 50% ON mode (load shed).

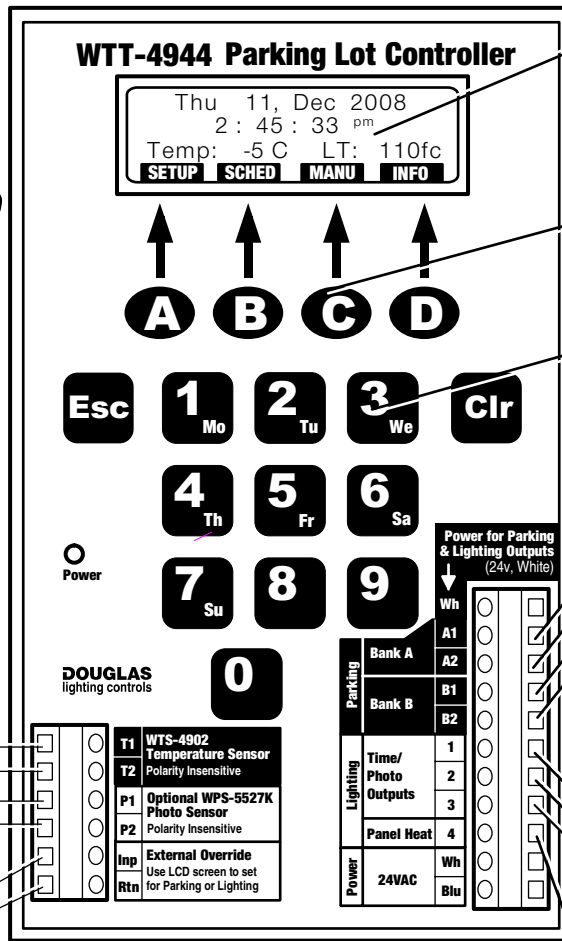

LCD Display

- The Main Menu displays the date/time, the temperature measured and the light level measured if a WPS-5527K Photo Sensor is used.
- All of the Controller's Program Menus display prompts and information to guide you in viewing and editing them.

Menu Buttons

- Use the buttons to scroll through and make selections in the Menus in the LCD display.

Keypad

- Use the numeric buttons to make selections and enter information in the Controller's programs.
- ESCAPE and CLEAR buttons are to the left and right of the numeric buttons.

Temperature-Controlled Outputs (4)

- Use to connect to the relays that control parking lot receptacles.
- The relays to be connected are split into two equal groups: BANK A and BANK B.
- Each Bank is set to switch ON and OFF in response to the ambient temperature and the Duty Cycle schedules.

Time/Photo-Controlled Outputs (3)

- Use to connect to the relays that control lighting circuits such as parking lot and security lights.
- The relays switch ON and OFF, in response to the time and/or photo settings.

Panel Heater Output

- Use to connect a panel heater, which must be installed if the Controller is mounted outdoors.
- The panel heater switches ON in response to a sensor built into the WTT-4944 Controller.
- If no panel heater is required, this can be used as a fourth Timer/Photo Output.

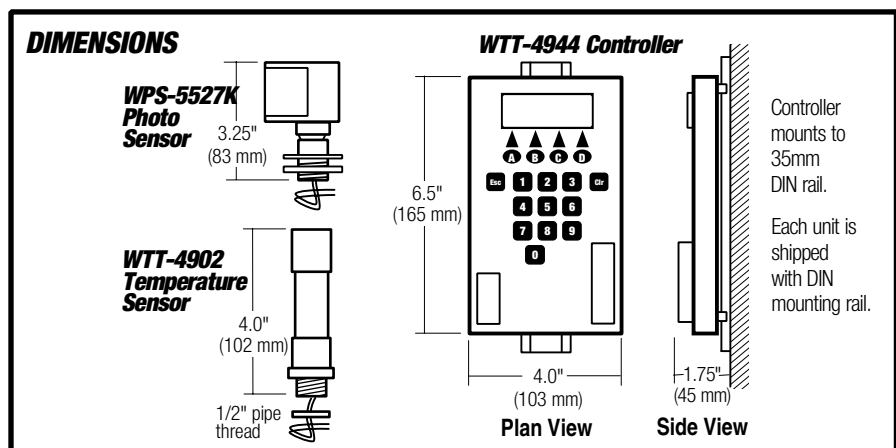

Specifications

General

- Power:
24VAC / 100mA Class 2 Low Voltage device.
Power rating does not include power used to switch relays.
- Temperature Sensor:
A Douglas WTT-4902 Temperature Sensor connects to Input Terminals T1 and T2 with a twisted pair of unshielded 18-ga. wire.
Maximum wire length is 500' (150m).
- Photo Sensor (optional):
A Douglas WPS-5527K Photo (daylight) Sensor connects to Inputs Terminals P1 and P2 with a twisted pair of unshielded 18-ga. wire.
Maximum wire length is 500' (150m).

Outputs

- Temperature (A1, A2, B1, B2):
Douglas relays and relay scanners connect to time/temperature-controlled outputs A1, A2, A3 and A4.
Bank A (A1 & A2) and Bank B (B1 & B2) each carry approximately half of the total output load. The output load within each Bank can be divided in any manner between Bank outputs 1 & 2.
Bank A and Bank B outputs alternate with each other. That is, for 25% and 50% duty cycles, one Bank is ON while the other is OFF, and for 75% and 100% duty cycles their ON periods overlap.
Maximum number of relays per output is 4.
- Time/Photo (1,2,3):
Douglas relays and relay scanners connect to time/photo-controlled outputs 1, 2 and 3.
Maximum number of relays per output is 4.
Maximum number of relay scanners per output is 4.

Outputs (continued)

- Heater or Time/Photo (4):
A strip heater connects to output 4. The strip heater is controlled by a sensor built into the WTT-4944 Controller.
As the Controller must operate in an ambient temperature above freezing, a strip heater must be installed when the panel is mounted outdoors.
If the panel is installed indoors, time/photo-controlled relays or scanners can connect to the output, with a maximum of 4 relays or 4 relay scanners.

Environment

- Stationary, non-vibrating, non-corrosive atmosphere and non-condensing humidity.
- Ambient operating temperature:
32° F to +120° F (0° to +50° C).

INSTALLATION INSTRUCTIONS

1. The WTT-4944 Controller is mounted inside a relay control panel. Try to locate the panel indoors, if possible, in an area that is easily accessible for programming.

If mounting outdoors, you must use a NEMA 4 enclosure. You must also mount a strip heater inside the panel as the Controller requires an ambient operating temperature above freezing.

2. Mount the WTT-4944 Controller inside the relay panel. The controller mounts to 35mm DIN rail, as shown in the drawing at the lower right. Mounting rail is supplied with each Controller unit. If mounting into a Douglas Relay Control Panel, the DIN rail will already be installed.

3. Mount the WTT-4902 Temperature sensor outdoors, away from any heat-producing devices. The base of the sensor is 1/2" pipe thread. The sensor is supplied with a mounting nut to suit mounting to a 1/2" knock out. Maximum wire length from sensor to Controller is 500'/150m.

4. If installing a WPS-5527K Photo Sensor, mount the sensor in a location where artificial light does not shine on it and mount it so that its face is pointing toward the Northern horizon.

Although the Photo Sensor is weatherproof, it is best to mount it either indoors pointing outward or in a sheltered area so that its measurements will not be affected by dirt, ice or snow build-up.

The sensor has a plastic mounting nipple that can be threaded to a 1/2" pipe thread. A mounting nut is supplied to suit mounting to a 1/2" knock out. A good place for mounting is the underside of a junction box. Maximum wire length from sensor to controller is 500'/150m.

5. From the relay schedule, determine which relays control the parking lot receptacles. Group these relays into 2 groups, which will be Bank A and Bank B. Make sure the loads are evenly distributed between Bank A and Bank B. Relays assigned to Bank A will connect to Controller Output terminals A1 and A2, and relays assigned to Bank B will connect to terminals B1 and B2. Relay loads within each Bank can be distributed in any manner between Bank terminals 1 and 2.

Connect each group's relays in parallel to the corresponding PARKING terminal of the Controller. Ensure that no more than 4 relays are connected together - a scanner must be used with more than 4 relays and no more than 4 scanners can be connected to one output terminal. Also make sure that no outputs are connected together.

6. From the relay schedule, determine which relays control the parking lot lights. Group these relays into 3 groups and connect each group to a LIGHTING terminal (1, 2 or 3) of the Controller. If you are not installing a strip heater, you can connect a 4th group to LIGHTING terminal 4.

Connect each lighting group's relays in parallel to the terminal. Ensure that no more than 4 relays are connected together - a scanner must be used with more than 4 relays and no more than 4 scanners can be connected to any output terminal. Also make sure that no outputs are connected together.

7. If using a panel heater, install it in the panel and connect it to LIGHTING terminal 4.
8. If using an external override switch (for lighting outputs) or an EMS-controlled override circuit (for parking outputs), connect it to the white and to the INP (EXTERNAL OVERRIDE) input. Connect the RTN (EXTERNAL OVERRIDE) input to blue from the same power source.
9. Connect the 24V transformer to the POWER output terminals.
10. Use the Controller's manual override (MANU) mode to verify that the correct relay groups are being switched by each Controller output.

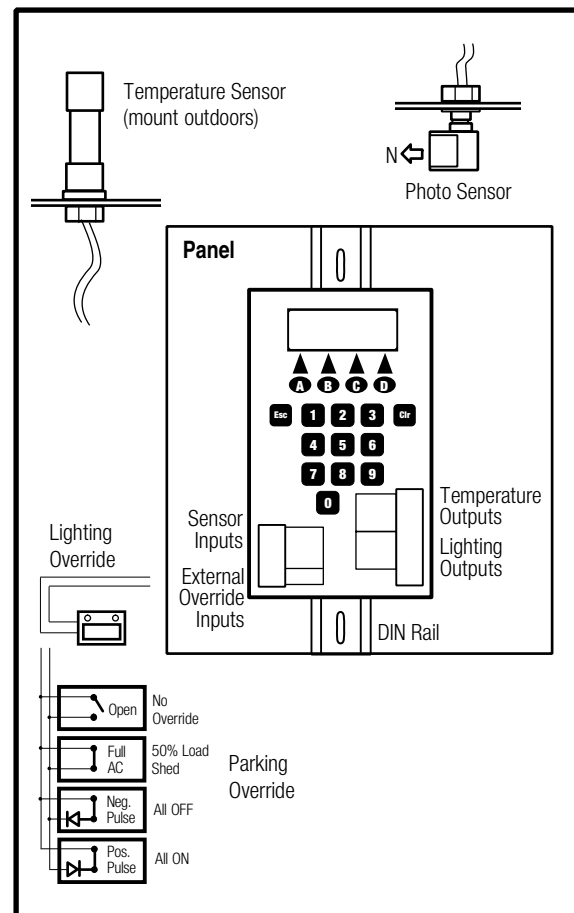

Main Menu

MAIN MENU

The Main Menu is what initially appears in the LCD display. It displays the current date and time, the current temperature as measured by the temperature sensor and the current daylight level as measured by the photo sensor, if used.

At the bottom is the Menu Bar of the 4 Menus, each selected by pressing the corresponding Menu Button.

To use the Main Menu:

1. Read the current date, time, temperature and daylight level (when a photo sensor input is used) as displayed.
2. To select a Menu from the Menu Bar, press the Menu Button that is pointing to it. The first screen of that menu will appear in the LCD display. The 4 Menus you can select in the Menu Bar are:

A) SETUP Menu

Allows you to set the time and date, enable/disable daylight savings time, program how output relays to parking lot receptacles and how lights are activated by temperature and (if used) daylight level readings, specify the type of override input circuit, and clear all or some of the Controller's memory.

(B) SCHED (SCHEDULE) Menu

Allows you to set weekly schedules for when the Controller turns groups of output relays ON or OFF.

(C) MANU (MANUAL) Menu

Allows you to set or activate manual overrides, where you switch groups of output relays ON or OFF directly from the Controller.

(D) INFO (INFORMATION) Menu

Allows you to access data stored in the Controller's memory.

3. The display will revert to the Main Menu after 5 minutes of inactivity in any of the other Menus.
4. In the event of a power loss, all saved schedules and settings are retained in the Controller's memory: no information is lost. Time/date is retained for 72 hours.
5. Below is a summary of the main commands for each of the 4 Menus in the Menu Bar:

SETUP

- (a) Adjust Date/Time
Set the current date/time on the Main Screen
- (b) Daylight Settings
Delete or add Daylight Savings time change
- (c) Parking Settings
Set the trigger points for parking lot receptacles
- (d) Photo Settings
Allow lighting outputs to respond to daylight readings
- (e) Input Options
Select an override input, if used
- (f) Clear Memory
Clear program(s), data or return to default

SCHEDULE

- (a) Select Parking
Set weekly schedules for parking lot receptacle relay actions
- (b) Select Lighting 1
Set weekly schedules for lighting group 1 relay actions
- (c) Select Lighting 2
Set weekly schedules for lighting group 2 relay actions
- (d) Select Lighting 3
Set weekly schedules for lighting group 3 relay actions
- (d) Select Lighting 4
Set weekly schedules for lighting group 4 (when used instead of a panel heater) relay actions

MANUAL

- (a) Parking Testing
Select override for parking outputs and the temperature that triggers it
- (b) Lighting Override
Select override for lighting outputs and for which group(s)

INFORMATION

- (a) Memory Status
Display the number of schedules stored in memory
- (b) View Event Log
Display Controller actions, starting with the most recent
- (c) FC/Lux Help
Display conversion ratio of footcandle to LUX units
- (d) About
Display the current version of Controller internal software

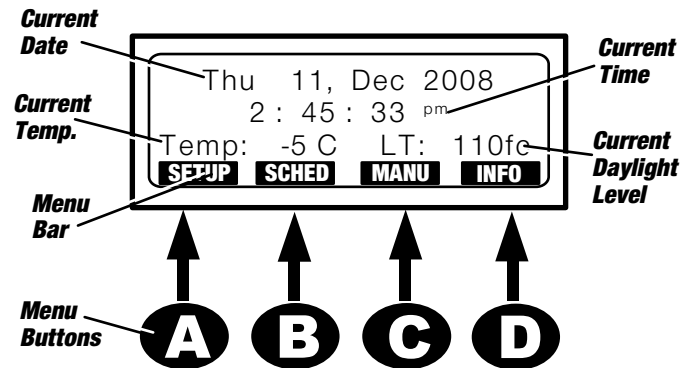

Setup Menu

SETUP MENU

Use the SETUP Menu to configure the general settings of the WTT-4944 Controller.

To access the SETUP Menu:

From the MAIN Menu, press the A Button to display the SETUP Menu.

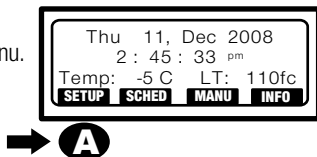

To navigate through the SETUP Submenus:

Use the A and B buttons to scroll through the Submenu list.

Use the D button to select the highlighted Submenu.

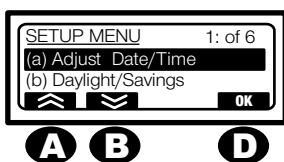

What the SETUP Submenus do:

ADJUST DATE/TIME

Set or change the current time and date displayed on the MAIN Menu.

Default is Jan. 12, 2003, 1:00 am.

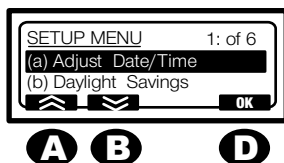

DAYLIGHT SAVINGS

Add the Daylight Savings Time option, which sets the time 1 hour ahead at 1:00 am on the first Sunday in April and 1 hour back at 2:00 am on the last Sunday in October.

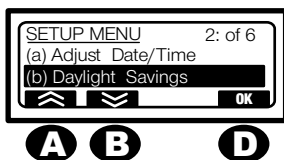

PARKING SETTINGS

Set the Duty Cycle SetPoint temperatures, Duty Cycle duration, Panel Heater status, Summer Mode status and Temperature Units used for relays controlling parking lot receptacles.

The Defaults are:

Duty Cycle SetPoint temperatures:

25%: -10° C

50%: -20° C

75%: -30° C

100%: -40° C

Duty Cycle time: 20 minutes

Panel Heater: OFF

Summer Mode: ON

Temperature Units: °C

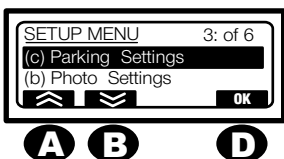

What the SETUP Submenus do (continued):

PHOTO SETTINGS

Activate Global Photo Control, which allows output relays to respond to the intensity of daylight readings of the Photo Sensor, when one is used.

Default is ON.



INPUT OPTIONS

Set the type of input device to be used for external override: PARKING EMS (contact switches, usually controlled by EMS) or LIGHTING (remote switch).

Default is LIGHTING.

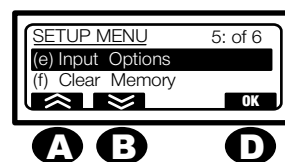

CLEAR MEMORY

Reset specific parts of the Controller's memory.

The choices are:

(a) CLEAR PROGRAMS
Remove all schedules created in the SCHEDULE menu.

(b) CLEAR LOGS
Retain programming, but clear logged event data.

(c) DEFAULT PARKING
Return to the default settings for parking receptacle relays:
Duty cycle SetPoints: (25%) -10°C, (50%) -20°C, (75%) -30°C, (100%) -40°C;
Duty cycle time: 20 minutes.

(d) FACTORY DEFAULTS
Clear entire memory and return to all the default settings.

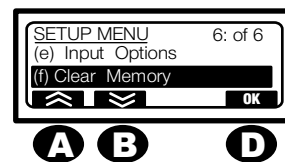

Details for using the Setup Submenus are on the following pages

NOTE:

When using any menu or submenu, pressing the CLEAR key will erase any unsaved information entered into the active screen and pressing the ESCAPE key once will erase any unsaved information and return you to the previous menu or submenu used.

DOUGLAS
lighting controls

Setup Menu: Date/Time, Daylight Savings

SETUP MENU: SETTING DATE & TIME

Use the ADJUST DATE/TIME Submenu to set or change the displayed Date and Time. If the displayed date/time is incorrect, you should reset it to the correct date/time before you start any other programming.

In the event of a power failure, the date/time setting is retained for 72 hours before reverting to Default (Jan. 12/03, 1:00 am).

To set the Date and Time:

1. Display the SETUP Menu, if necessary, by pressing the A button.

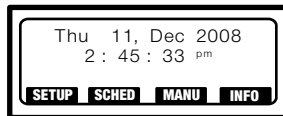

A

2. Scroll up the Submenu list, by pressing the A button, or scroll down, by pressing the B button, until (a) Adjust Date/Time is highlighted.



A B D

Select **OK** by pressing the D button.

3. A new screen appears, displaying the date and time recorded by the Controller.

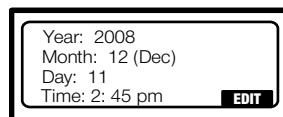

D

Select **EDIT**.

4. Another screen appears, prompting you to enter the correct year (last 2 digits).

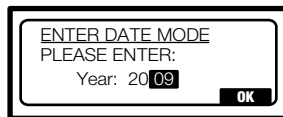

D

Using the numeric keypad, enter the correct digits, then Select **OK**.

5. Another screen appears, displaying the year you entered and asking if it is correct.

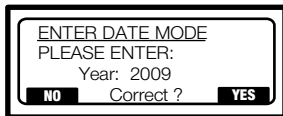

A D

If correct, select **YES** to save. If not, select **NO**, re-enter the correct digits, then select **OK** to save.

6. More screens appear, prompting you to enter the correct month, day, hour, minute and AM/PM.

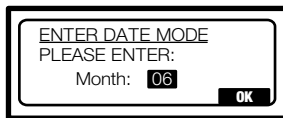

D

Follow the same procedure as in Steps 4 & 5 to enter and save the correct 2 digits for the month, day and hour.

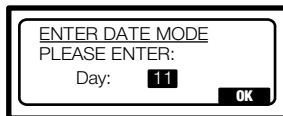

D

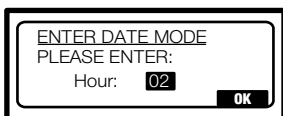

D

To set the Date and Time (continued):

7. Follow the same procedure as in Steps 4 & 5 to enter and save the correct 2 digits for the minute.

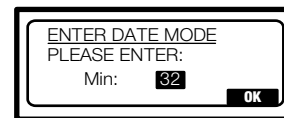

D

8. For AM/PM, select the correct value by toggling with the A (toggle left) or B (toggle right) button, then save by selecting **OK**.

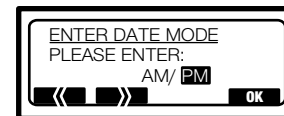

A B D

9. After you make your selections, the LCD returns to the MAIN Menu, displaying the date and time values you entered. (The Controller automatically computes the day of the week and the seconds.)

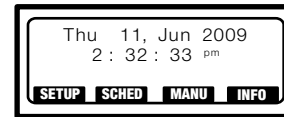

SETUP MENU: DAYLIGHT SAVINGS OPTION

Use the DAYLIGHT SAVINGS Submenu to remove or add the Daylight Savings option, where the time is automatically advanced one hour at 1:00 am on the second Sunday of March and set back one hour at 2:00 am on the first Sunday of November. For units commissioned prior to 2007, the time would be advanced on the first Sunday of April and set back on the last Sunday of October.

Default is ON. If there is no Daylight Savings Time in your area, you should disable this option.

To select/de-select Daylight Savings:

1. Display the SETUP Menu, if necessary, by pressing the A button.

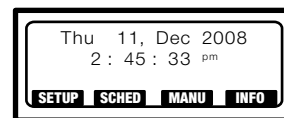

A

2. Scroll up the Submenu list, by pressing the A button, or scroll down, by pressing the B button, until (b) Daylight Savings is highlighted.



A B D

Select **OK**.

3. The Daylight Savings screen appears. Toggle left (by pressing the A button) or toggle right (by pressing the B button) to highlight **ON** or **OFF**.



A B D

Select **OK** to save.

4. After you save your selection, the LCD automatically returns to the MAIN Menu.

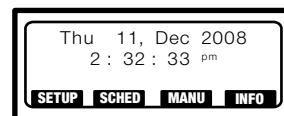

Setup Menu: Parking Settings

SETUP MENU: PARKING SETTINGS

Use the PARKING SETTINGS Submenu to set the parking lot receptacle Duty Cycles, which determine what trigger temperatures will activate each Bank of receptacles and for when and how long (See DUTY CYCLE insert below).

The PARKING SETTINGS Submenu also allows you to activate the panel heater, enable or disable the Summer Mode option and specify the temperature units (C° or F°).

DUTY CYCLE

The parking lot receptacles activated by the controller are split into two groups, each with about the same output load: BANK A (all receptacle circuits connected to Controller output terminals A1 & A2) and BANK B (all receptacle circuits connected to Controller output terminals B1 & B2).

Each Bank will be turned ON for a portion of a fixed time period, 1 to 60 minutes, called the DUTY CYCLE. Depending on the air temperature the Temperature Sensor measures at the start of the Duty Cycle, each Bank is turned ON for a longer or shorter portion of the cycle period. The lower the measured air temperature, the longer the Banks will remain ON.

The 2 Banks remain ON for a fixed segment -0%, 25%, 50%, 75% or 100%- of each Duty Cycle, in response to trigger temperature values measured at the start of the Duty Cycle, called SETPOINTS.

At the **100% SETPOINT**, Banks A and B are both turned ON for the entire Duty Cycle. For instance, if the Duty Cycle were 10 minutes long and the 100% SetPoint were -40° C, Bank A and Bank B would both stay ON for all 10 minutes of the Cycle whenever the temperature measured at the start of the cycle was -40° C or less.

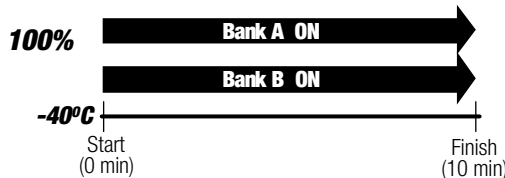

At the **75% SETPOINT**, Bank A is turned ON for the first 75% of the Duty Cycle, and Bank B for the last 75%. For a 10-minute Duty Cycle and a 75% SetPoint of -30° C, Bank A would stay ON for the first 7.5 minutes and Bank B would stay ON for the last 7.5 minutes whenever the temperature measured at the start was -30° C or any lower value to the 100% SetPoint of -40°.

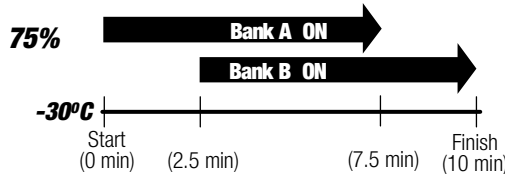

At the **50% SETPOINT**, Bank A is turned ON for the first 50% of the Duty Cycle and Bank B for the last 50%. For a 10-minute Duty Cycle and a 50% SetPoint of -20° C, Bank A would both stay ON for the first 5 minutes and Bank B for the last 5 minutes whenever the temperature measured at the start was -20° C or any lower value to the 75% SetPoint of -30°.

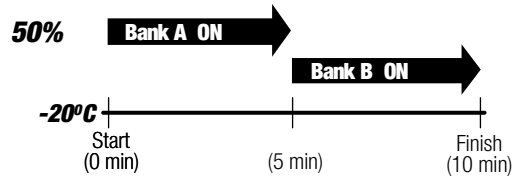

At the **25% SETPOINT**, Bank A is turned ON for the first 25% of the Duty Cycle and Bank B for the last 25%. For a 10-minute Duty Cycle and a 25% SetPoint of -10° C, Bank A would both stay ON for the first 2.5 minutes and Bank B for the last 2.5 minutes whenever the temperature measured at the start was -10° C or any lower value to the 50% SetPoint of -20°. For any measured starting temperature above -10° C, both Banks remain OFF during the entire cycle.

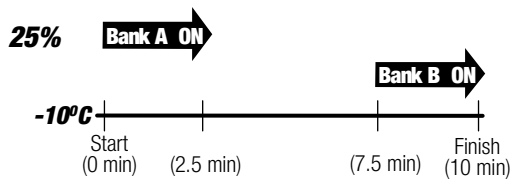

If the Controller is configured with the *Parking* input option (EMS controlled), the Banks can set to 50% mode, where each Bank is turned ON at its normal starting time for each SetPoint, but only remains ON for half as long as the normal duration.

To access the Parking Settings Submenu:

1. Display the SETUP Menu, if necessary, by pressing the A button.

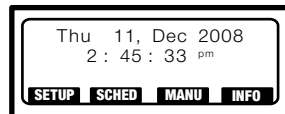

2. Scroll up the Submenu list, by pressing the A button, or scroll down, by pressing the B button, until (c) *Parking Settings* is highlighted.



Select OK.

To set the Duty Cycle SetPoints:

1. When the *Parking Settings* Submenu appears, scroll to (a) *Duty SetPoints*, then select OK.



2. The *View/Edit Setpoint* screen appears, displaying a list of Duty Cycles with the last (or default) Set Point temperature.



Scroll to the first Duty Cycle to be set, then select EDIT.

(continued on next page)

DOUGLAS
lighting controls

Setup Menu: Parking Settings

To set Duty Cycle SetPoints (continued):

- A screen appears showing the selected SetPoint.

To change the (-) value to a (+), or vice versa, press the A button.

To change the numeric value, press the numeric keypad corresponding to the new number.

For example, to change the -10C to -12C, press the 1 and 2 keys.

NOTE: You must select a SetPoint temperature that is lower than that of any preceeding (lower %) Duty Cycles and higher than that of any following (higher %) Duty Cycles. Otherwise, the system will not let you proceed.

- To save, select OK by pressing the D button.

- Repeat steps 2-4 to change the SetPoint temperatures for the other Duty Cycles. For each Duty Cycle, the SetPoint temperature must have a value between the Setpoint temperatures of the adjacent Duty Cycles.

When finished, press the ESCAPE key to return to the Parking Settings Submenu.

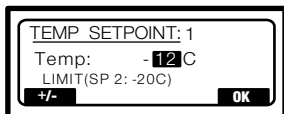
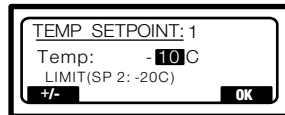

To set the Duty Cycle Time:

- When the Parking Settings Submenu appears, scroll to (b) DutyCycle Time, then select OK.

- The Duty Time screen appears, displaying the last (or default) Duty Cycle time.

- To change the value, use the numeric keypad to enter the new number(s) then select OK to save the change.

After you save the Duty Cycle time, the display will return to the Parking Settings Submenu.



To activate/de-activate the Panel Heater:

Use the PANEL HEATER option to configure Lighting Output #4 to connect to a strip heater in the panel housing the Controller (ON). If the PANEL HEATER option is left at default (OFF) Lighting Output #4 is configured for lights.

The panel heater will turn on whenever a sensor built into the Controller measures a temperature of 0°C or lower. (The Controller cannot operate in an ambient temperature below freezing.)

- When the Parking Settings Submenu appears, scroll to (c) Panel Heater and select OK.

- The Panel Heater screen appears. Toggle left or right to select ON or OFF.

Select OK to save. The screen will return to the Parking Settings Submenu.



To activate/de-activate Summer Mode:

Use the SUMMER MODE option to activate or de-activate Summer Mode, where all the relays to parking receptacles are turned ON whenever the temperature reaches +10 C°. This allows customers to use the receptacles for other appliances such as car vacuums, battery chargers, etc.

- When the Parking Settings Submenu appears, scroll to (d) Summer Mode and select OK.

- The Summer Mode screen appears. Toggle to select ON or OFF.

Select OK (D button) to save. The screen will return to the Parking Settings Submenu.

When ON is selected, the SUMMER icon will be displayed when you return to the Main Screen.

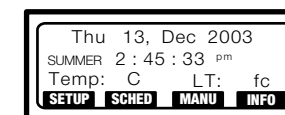
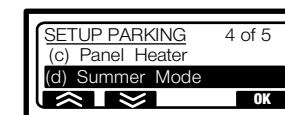

To select the Temperature Units:

Use the TEMPERATURE UNITS option to select F° (Fahrenheit) or C° (Celsius) for all temperatures displayed. Default is C°.

- When the Parking Settings Submenu appears, scroll to (e) Temperature Units and select OK.

- The Temp Units screen appears. Toggle to select °C or °F.

Select OK to save. The screen will return to the Parking Settings Submenu.

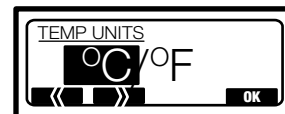
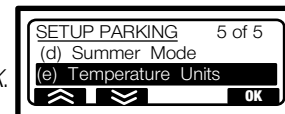

Setup Menu: Photo/Inputs/Clear Memory

To activate/de-activate Photo Settings:

Use the PHOTO SETTINGS option to activate or de-activate Photo Control, where the lighting outputs can be regulated by readings from a photo sensor. Default is ON.

If you will be scheduling any photo-enabled actions, this

1. Display the SETUP Menu, if necessary, by pressing the A button.

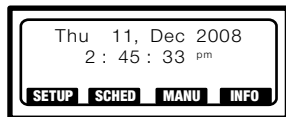

2. Scroll the Submenu list until (d) Photo Settings is highlighted.



3. The Photo Control screen appears. Toggle to select ON or OFF.



Select OK to save. If OFF was selected, The screen will return to the SETUP Menu.



When ON is selected, the Photo icon (☀) will appear in the upper right corner when you return to the Main Screen.

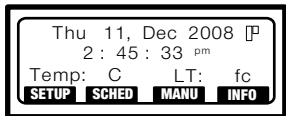

To select the type of Override Input:

Use the INPUT OPTIONS to select the type of Override Input, if one is to be connected.

There are two types of Override Inputs:

- (a) LIGHTING, where a remote manual switch can turn any timer/photo-controlled lighting output relays ON or OFF;
- (b) PARKING, where contacts controlled by an external EMS can turn temperature-controlled parking output relays ON or OFF, or activate the 50% Mode for their Duty Cycles.

1. Display the SETUP Menu, if necessary, by pressing the A button.

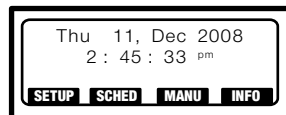

2. Scroll the Submenu list until (e) Input Options is highlighted, then select OK.



3. The Input Options screen appears.

The 2 options, LIGHTING and PARKING EMS appear at the right, with one highlighted. If only one option appears, press the A or B button until both are displayed.



Toggle up or down to select the desired option, then save by selecting OK.

To clear the Controller's Memory:

Use the CLEAR MEMORY option clear all or part of the instructions and/or logged data stored in the Controller's memory.

1. Display the SETUP Menu, if necessary, by pressing the A button.

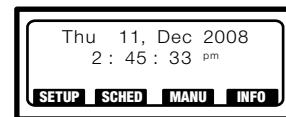

2. Scroll the Submenu list to (f) Clear Memory, then select OK.



3. The Clear Options list appears:

(a) CLEAR PROGRAMS
Remove all output schedules programmed in the Controller, but retain logged information.



(b) CLEAR LOGS
Remove records of all logged events, but retain programmed instructions.



(c) DEFAULT PARKING
Remove all programmed instructions and settings relating to parking outputs.



(d) FACTORY DEFAULTS
Remove all programmed instructions and logged events and return to the factory settings:



Time: Jan 02/03 1:00am
Events: none
Schedules: none
Photo Enable: ON
Temp Units: C°
Daylight Savings: ON
Summer Mode: ON
Input Option: Lighting (remote sw.)
Panel Heater: OFF
Duty Cycles Setpoints:
-10°C, -20°C, -30°C, -40°C
Duty Cycle Time: 20 minutes

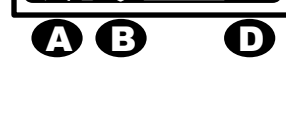

4. Select the desired option by highlighting it and selecting OK.

A screen appears asking Are You Sure??? If you are sure, select YES by pressing button A.

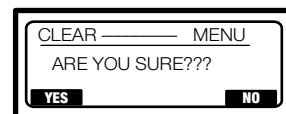

(NOTE: you cannot undo this operation; once the information is erased, it cannot be retrieved.)

5. The screen will display messages on how the clearing is proceeding, then return to the Clear Options screen when all the data is erased.

Schedule Menu: Parking Outputs

SCHEDULE MENU

Use the SCHEDULE Menu to set daily schedules for enabling or disabling the Parking Receptacle Outputs and for turning ON, photo-enabling or turning OFF each group of Lighting Outputs.

When enabled, all relays for the Parking Receptacle Outputs will be ON for their Bank's designated portion of the Duty Cycle whenever the ambient temperature falls to the 25% SetPoint value or lower. During Summer Mode, they will also remain ON whenever the ambient temperature reaches 10 C° or higher. When disabled, all parking receptables remain OFF regardless of the temperature or mode.

When enabled (ON), the relays for each group of Lighting Outputs remain ON. When disabled (OFF), the relays in the group remain OFF. Each Lighting Output group can also be photo-enabled, where its relays are turned ON whenever the daylight level, as measured by the Photo Sensor, falls below a specified value called the LOW SETPOINT and remain ON until the daylight level rises above a specified higher value called the HIGH SETPOINT.

To set Parking Outputs Schedules:

1. Display the SCHEDULE Menu, if necessary, by pressing the B button.

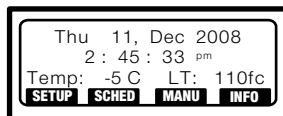

B

2. The Schedules screen appears.

First select the Output group to create a schedule for. The choices presented are: *Parking* (all Parking Outputs), *Lighting Output 1*, *Lighting Output 2*, *Lighting Output 3*, and *Lighting Output 4* (not available if Output 4 is used for a panel heater).

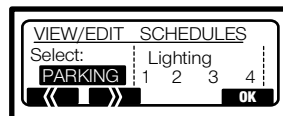

A B D

Toggle right or left to highlight *PARKING*, then select *OK*.

3. The View Parking screen appears. Any events already scheduled for the Parking outputs are listed.

Select *NEW* to go to the *New Parking Schedule* screen.



A B D

4. Use this screen (*New Parking*) to create a new weekly Parking schedule.

The schedule will specify what time of day, and on which days of the week, the following actions occur

ENABLE

All parking outputs are enabled and will be ON during their Bank's active phases of any triggered Duty Cycles.



A B C D

To set Parking Outputs Schedules (continued):

DISABLE

All parking outputs are disabled (stay OFF) until an ENABLE action is scheduled.

NO ACTION

the output relays do not change state during the time period specified. This is a useful function: It may be easier to schedule a NO ACTION event for a particular day or time rather than eliminating a scheduled event and then having to create and schedule another.

Saving Schedules

When you save an event, by pressing the D button when you are in the SCHEDULE Menu, that event is only saved in the Controller's temporary memory.

Events saved within the SCHEDULE Menu will not be saved to permanent memory until you return to the MAIN Menu by repeatedly pressing the ESC button. Otherwise, they will be lost when you exit the SCHEDULE menu.

5. Set the time of day for the first event:

Select *TIME* by pressing the A button.

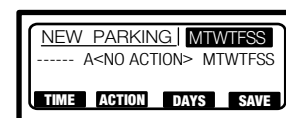

A

When the *Schedule Time* screen appears, enter the time the event is to start with the numeric keypads, toggle to select *AM* or *PM* with the C button, then select *OK*.

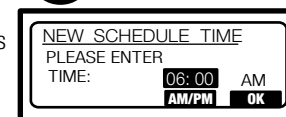

C D

6. Select the action for the first event:

Select *ACTION* by pressing the B button.



B

When the *Edit Parking Action* screen appears, scroll to the type of action desired, then select *OK*.



A B D

7. Set the days of the week for the event:

Select *DAYS* by pressing the C button.

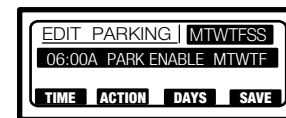

C

When the *Select Schedule Days* screen appears, select the days by selecting or un-selecting their check mark with the number keys (M=1, T=2, W=3, etc.). The default is all days selected.

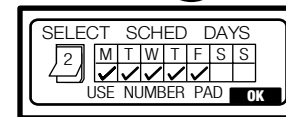

D

Select *OK*. The *View Parking* screen appears, showing the scheduled event. Press *SAVE* (D) to save to temporary memory.

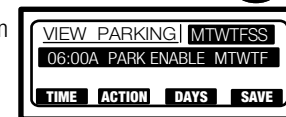

D

8. Repeat steps 5-7 to schedule the other Parking output actions.

To save the scheduled events in the Controller's permanent memory, you must repeatedly press the ESC button until the MAIN Menu appears.

Schedule Menu: Lighting Outputs

To set Lighting Outputs Schedules:

1. Display the SCHEDULE Menu, if necessary, by pressing the B button.

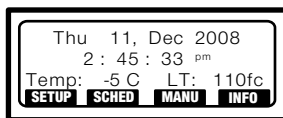

B

2. The Schedules screen appears.

First select the Lighting Output to create a schedule for. The choices presented are: *Lighting Output 1*, *Lighting Output 2*, *Lighting Output 3*, and *Lighting Output 4* (not available for scheduling if used for a panel heater).

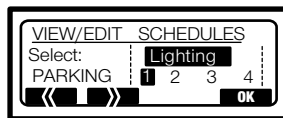

A B D

Toggle left or right to highlight *Lighting 1* (for example), then select by pressing OK.

3. The View Lighting 1 screen appears. Any events already scheduled for Lighting Output 1 are listed.



A B D

Select NEW (D button) to go to the New Parking Schedule screen.

4. This is the Screen you use to create a new weekly Lighting Output group schedule.

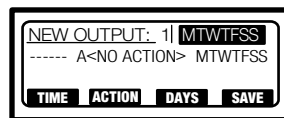

A B C D

The schedule will specify what time of day, and on which days of the week, the following actions occur:

ON

All Output relays remain ON until an OFF action is scheduled.

OFF

All Output relays remain OFF until an ON action is scheduled.

PHOTO ENABLED

All Output relays are turned ON whenever the Photo Sensor measures the Low SetPoint daylight level and are turned OFF whenever the Photo Sensor measures the High SetPoint daylight level*.

NO ACTION

The Output relays do not change state during the time period specified. This is a useful function: it can be easier to schedule a NO ACTION event for a particular day or time period rather than eliminating a scheduled event and then having to create and schedule another.

*Photo Enable

Photo Enable is used when a 5527K Photo Sensor is connected to the Controller.

When the measured daylight level goes below the Low Setpoint the output relays turn ON. The opposite occurs when the measured daylight level goes above the High Setpoint.

Switching actions only occurs when the daylight level passes through a setpoint or at the start of the PHOTO ENABLED action.

To prevent any false switching from temporary light level changes, there is a 3-minute delay in switching the relays.

Typical Low and High SetPoints for an outdoor parking lot setting are 5fc and 20fc. For an interior setting, typical values are 700fc and 1000fc.

To set Lighting Output Schedules (continued):

5. Set the time of day for the first event:

Select TIME by pressing the A button.

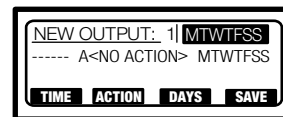

A

When the Schedule Time screen appears, enter the time the event is to start with the numeric keypads, toggle to select AM or PM with the C button, then select OK.

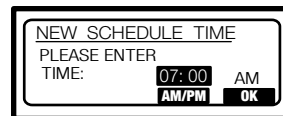

C D

6. Select the action for the first event:

Select ACTION by pressing the B button.

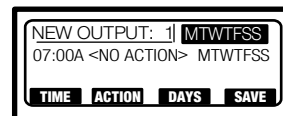

B

When the New Schedule Action screen appears, scroll to the type of action desired, then select OK.



A B D

(If ON, OFF or NO ACTION was selected, go to step 8.)

7. If PHOTO ENABLED was selected, the SetPoint Setup Screen appears.

Set the high level by highlighting (A button), entering the value with the numeric keypads, then selecting OK.

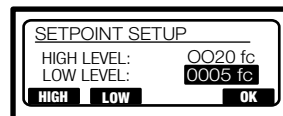

A B D

Set the low level by highlighting (B button), entering the value with the numeric keypads, then selecting OK.

8. When the next screen appears, set the days of the week for the first event:

Select DAYS by pressing the C button.

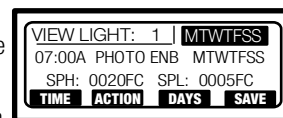

C

When the Select Schedule Days screen appears, select the days by selecting or un-selecting their check mark with the number keys (M=1, T=2, W=3, etc.). The default is all days selected.

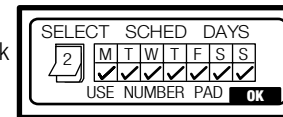

Save the days-of-week setting by selecting OK.

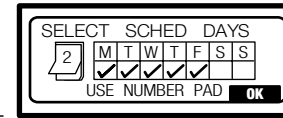

D

The Edit Output screen appears, showing the scheduled event. Press SAVE.

9. Repeat steps 5-8 to schedule the other events for the first Light Output.

Using the same procedures, schedule the events for the other Light Outputs.

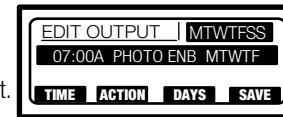

D

To save the schedules to the Controller's permanent memory, you must repeatedly press the ESC button until the MAIN Menu appears.

DOUGLAS
lighting controls

Schedule Menu: Examples

Parking Outputs: Varied Hours of Operation

A parking lot is open 7:00 am - 11:00 pm Monday thru Friday, 7:00 am - 5:00 pm Saturday and closed Sunday. To schedule parking receptacles to be ON only during those hours when the lot is open:

- Schedule an ENABLE event for every day at 7:00 am and a DISABLE event for every day at 11:00 pm.
- Schedule a DISABLE event for Saturday at 5:00 pm.
- Schedule a NO ACTION event for Sunday at 7:00 am.



The parking lot receptacles will receive an ON signal every day at 7:00 am. This will activate them every day except Sunday, when the NO ACTION signal keeps them in their previous state, which is OFF (from the OFF signal received at 11:00 pm Saturday).

The parking lot receptacles will get a OFF signal every day at 11:00 pm turning them OFF if they are ON. On Saturday they are already OFF, as they received a previous OFF signal at 5:00 pm and on Sunday they are never activated.

The above is one of many ways to accomplish this type of day-to-day schedule using the ON, OFF and NO ACTION commands.

Lighting Output: ON from Dusk until Dawn

To schedule security lights to be ON from dusk until dawn every day:

- Schedule a PHOTO ENABLE event every day before dawn.

Set the high SetPoint and low SetPoint so the light output group turns OFF at dawn and ON at dusk, respectively.



Every day, the security light output group will receive a PHOTO ENABLE signal at 4:00 am.

They will be ON from the last time the light level crossed the low SetPoint, which was the previous dusk. They will later turn OFF when the measured light level crosses the high SetPoint at dawn.

Lighting Output: ON from Dusk until Closing

To schedule security lights to be ON from dusk until 11:00 pm every day:

- Schedule a PHOTO ENABLE event every day at a time before dusk. Set the low setpoint so the light output group will switch ON at dusk.
- Schedule a OFF event every day at closing time.

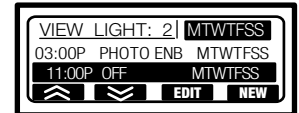

Every day, the security light output group will receive a PHOTO ENABLE signal at 3:00 pm. They will be OFF from the OFF signal received at 11:00 pm the previous day. They will turn ON when the measured light level crosses the low setpoint at dusk and will remain ON until the next OFF signal is received at 11:00 pm.

Lighting Output: ON from Opening until Dawn and ON from Dusk until Closing

To schedule security lights to be ON from 5:00 AM until dawn and from dusk until 11:00 pm every day:

- Schedule a PHOTO ENABLE event every day at opening time. Adjust the SetPoints so the light output group will turn OFF at dawn and ON again at dusk.
- Schedule a OFF event every day at closing time.

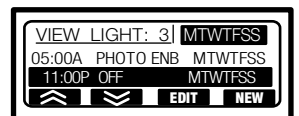

Every day, the security light output group will receive a PHOTO ENABLE signal at 5:00 am. They will be OFF from the OFF signal at 11:00 pm the previous day, and will turn ON since the measured light level is below the low SetPoint when the PHOTO ENABLE signal is initiated.

At dawn, when the high SetPoint is crossed, the lights will turn OFF, and will turn ON again when the low SetPoint is crossed at dusk. They will turn OFF when then OFF signal occurs at 11:00 pm.

NOTE:

When Using the SCHEDULE Menu, you can delete an event from an existing schedule by highlighting that event in the VIEW screen, then pressing the CLR button. Note that once an event is cleared, it cannot be recovered.

As events are only stored in temporary memory when you are working within the SCHEDULE Menu, they will be lost in the event of a power interruption. To permanently save them, you must go to the MAIN menu by repeatedly pressing the ESC button.

MANUAL MENU

Use the **MANUAL** Menu to switch the parking receptacle outputs or any of the lighting outputs directly from the keypad.

It is advisable to use the **MANUAL** Menu to turn the outputs **ON** and **OFF** when initially configuring the system to verify that relays are connected to the proper outputs.

You can also switch an individual output relay by using its **Manual Override Lever** (see insert).

It is not advisable to use the **MANUAL** Menu override or the **Manual Levers** in the relays for day-to-day switching. Instead, connect an external remote switch to the lighting outputs, or an **EMS** to the parking outputs, using the **Override Inputs**.

Override Lever

You can directly override a Douglas output relay by using the manual ON/OFF lever built into the relay. To override, use a slotted screwdriver to push the lever to the ON or OFF position, as shown in the diagram.

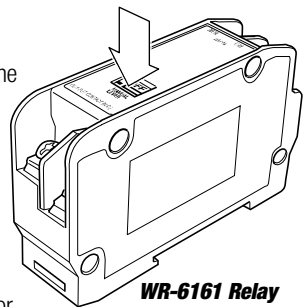

This is not recommended for day-to-day operation. Instead, use a Douglas remote switch (for lighting outputs), or EMS (for parking outputs), connected to the External Override Inputs.

To override the Parking Output Relays:

NOTE: Parking outputs that are disabled cannot respond to Manual Override. If they are disabled, you must first enable them using the **SCHEDULE** Menu.

1. Display the **MANUAL** Menu, if necessary, by pressing the **C** button.

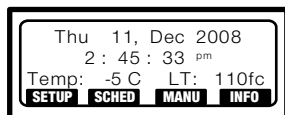

C

2. The **Manual Override** screen appears.

Toggle to select (a) **Parking Testing**, then press **OK**.



A B D

3. The **Parking Temp Override** screen appears.

Select an override Temperature that is low enough to trigger the parking outputs. Select (+) or (-) with the **A** button, the numerical value with the keypad, then press **OK**.

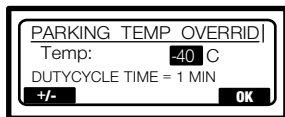

A D

4. All parking output relays with a duty cycle **ON** phase that would occur with an ambient temperature equal to or higher than the override value will turn **ON**. To turn all of the parking lot receptacle relays **ON**, use the 100% SetPoint value or lower.

When in parking testing mode, the test icon (t) will be displayed in the upper left corner of the Main Screen.

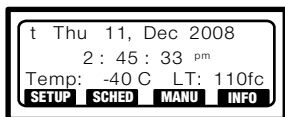

C

5. To disable the parking testing mode, display the **Parking Temp Override** screen and press the **B** button.

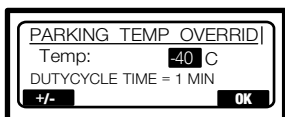

B

To override Lighting Output Relay Groups:

1. Display the **MANUAL** Menu, if necessary, by pressing the **C** button.

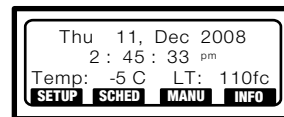

C

2. The **Manual Override** screen appears.

Toggle to select (b) **Lighting Override**, then press **OK**.



A B D

3. The **Lighting Outputs** screen appears.

Select the output groups to override by selecting or un-selecting their check marks with the number keys (1=1, 2=2, etc.). The default is no groups selected.

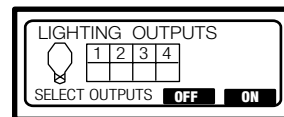

C D

NOTE: If lighting output group 4 is used for a panel heater, it cannot be overridden and won't appear on this screen.

4. Press the **C** or **D** button to turn the relays in the selected output groups **OFF** or **ON**, respectively.

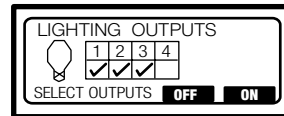

C D

INFORMATION MENU

Use the INFORMATION Menu to view information stored in the Controller's memory. You can view the number of schedules stored in memory, scroll through the last 100 logged events, and view the conversion factor for LUX to footcandle units and the version of the WTT-4944 software.

With this menu, you can also clear all logged events from the Controller's memory.

To view the Controller's Memory Status:

1. Display the INFORMATION Menu, if necessary, by pressing the D button.

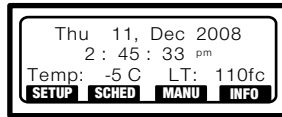

2. The INFORMATION Menu appears.

Toggle to select (a) Memory Status, then press OK.

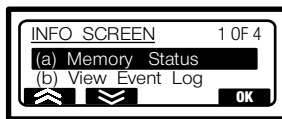

3. The System Memory Used screen appears. It is read-only.

The screen displays the number of programmed scheduled events currently stored in memory and the maximum number that can be stored. This lets you know how much memory is left for further programming.

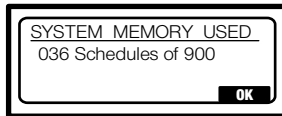

Press OK to return to the Information Menu.

To view the Log of Programmed Events:

1. Display the INFORMATION Menu, if necessary, by pressing the D button.

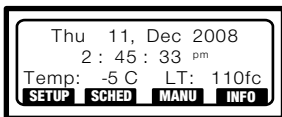

2. The INFORMATION Menu appears.

Navigate to select (b) View Event Log, then press OK.



3. The Log screen appears.

The screen displays the logged events in chronological order. It shows one event at a time, giving its type, the date & time it occurred, and its position in the logged events list.

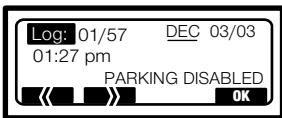

Initially, the oldest stored event is displayed. When 100 events are in memory, the Controller will automatically discard the oldest event to store the latest one.

To view the Log of Programmed Events (continued):

4. You can scroll backward or forward through the event list by pressing the A or B buttons.

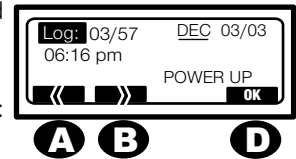

The type of events logged include: power up, enable/disable parking, duty cycle changes, and photo-enabled actions.

Press OK to return to the INFORMATION Menu.

5. While in the Log screen, you can clear all the logged events from the Controller's memory by pressing the CLR key. (This is the quickest way to do this.)

CAUTION: Once cleared you cannot recover the logged events data.

After clearing, the display will return to the INFORMATION Menu.

To view LUX/Footcandles Reference Information:

1. Display the INFORMATION Menu, if necessary, by pressing the D button.

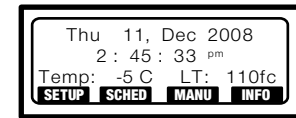

2. The INFORMATION Menu appears.

Navigate to select (b) FC -> Lux Help, then press OK.



3. The LUX to FC Conversion screen will appear. It is read-only.

This screen shows you the factor for converting Footcandle units to LUX, which is multiplying by 10.764.

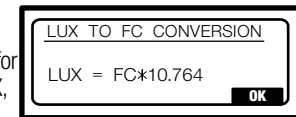

Press OK to return to the Information Menu.

To view Software Version Information:

1. In the INFORMATION Menu, navigate to select (d) About, then press OK.

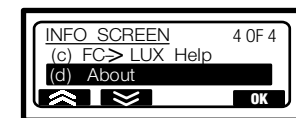

2. The WTT-4944 Parking Lot screen will appear. It is read-only.

This screen displays the software version used in the Controller.

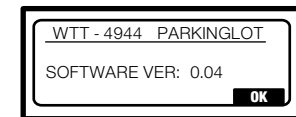

Press OK to return to the Information Menu.

Connections: Parking Lot Example

Parking Lot

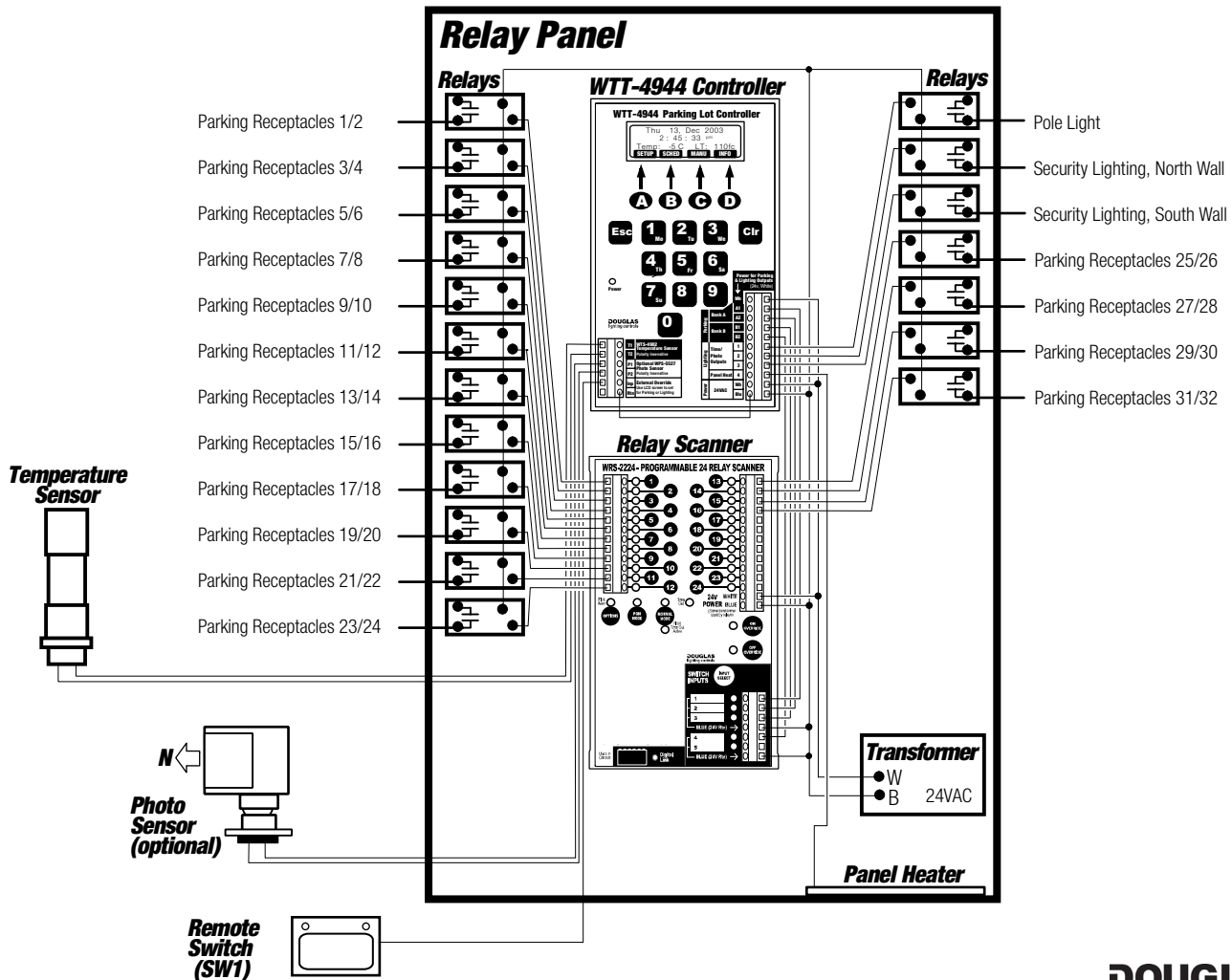
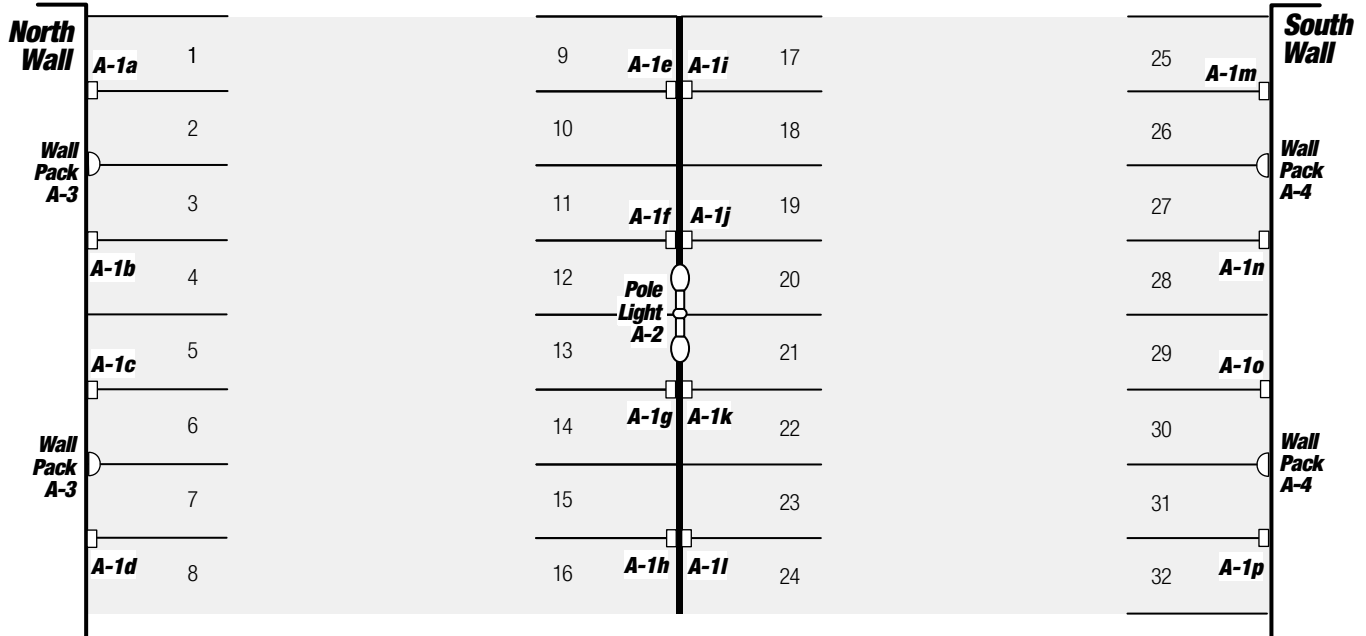

Connections: Parking Lot Example

Parking Lot Example

- The WTT-4944 Parking Lot Controller measures temperature with a WTT-4902 Temperature Sensor and daylight levels with a WPS-5527K Photo Sensor (optional) connected to its input terminals.

- The WTT-4944 Parking Lot Controller controls groups of relays that switch parking lot receptacles in response to time and to the temperature readings measured by the Temperature Sensor. These relays are connected to the Controller's *Parking* outputs. It also controls groups of relays that switch lighting circuits in response to time and daylight levels measured by the Photo Sensor. These relays are connected to the Controller's *Lighting* outputs.

- In this example, there are 16 parking lot receptacles, each supplying 2 adjacent parking spaces. There are 3 lighting circuits in the parking lot, the pole light in the center of the parking lot and the security lights on the North wall and on the South wall. As there are numerous output relays, a WRS-2224 Relay Scanner is used. 4 of its 5 inputs connect to the outputs of the Controller and 16 of its 24 outputs connect to output relays.

Refer to the relay schedule at the right, and the diagram on the previous page.

- The relays that control the parking lot receptacles connect to outputs 1-16 on the Relay Scanner. The relay that controls the pole light connects to Controller Lighting Output 1. The relays that control the wall security lights connect to Controller Lighting Outputs 2 and 3. The panel heater connects to Controller Lighting Output 4.

- A remote switch, SW1, which provides override for all the lighting circuits, connects to Power (from transformer) Wh and the In terminal of the Controller's *External Override* input, whose Rtn terminal connects to Power Blu.

- Using the Scanner keypad, parking lot receptacle output relays 1-4 are grouped together and assigned Input 1 on the Scanner, then the terminal of Scanner Input 1 is connected to Controller (Parking) Output A1. Parking lot receptacle output relays 5-8 are grouped together and assigned Input 2 on the Scanner, then the terminal of Scanner Input 2 is connected to Controller (Parking) Output A2. These are the relays in Bank A.

In like manner, parking receptacle relays 9-12 are grouped and assigned to Scanner Input 3, relays 13-16 are grouped and assigned to Scanner Input 4 and those Scanner inputs are connected to Controller Outputs B1 and B2. These are the relays in Bank B.

- The output relay controlling the pole light is connected directly to Controller (Lighting) Timer/Photo Output 1.

The output relays controlling the North and South wall security lights are connected directly to Controller Timer/Photo Outputs 2 and 3.

- In this example, the relay panel is mounted outside. Therefore, a panel heater is necessary. The panel heater is connected to Controller (Lighting) Output 4.

The Temperature Sensor (which must be outside) and Photo Sensor are mounted and connected to Controller Inputs T1/T2 and P1/P2 respectively.

- Using the Controller keypad, the parking settings are programmed for the parking lot receptacles. For setting duty cycles, Bank A is groups A1 & A2 (relays 1-8) and Bank B is groups B1 (relays 9-16).
- Using the Controller keypad, the lighting settings are programmed for the 3 lighting circuits: Lighting 1 (pole lights), Lighting 2 (North wall) and Lighting 3 (South wall).
- The MANUAL Menu on the Controller keypad is used to verify that the correct output relays are assigned to each Controller output.

Relay Panel: <u> A </u>						
Load Description	Circuit Number	Relay Number	Scanner I/O	Remote Switch	Parking Output	Lighting Output
Receptacles 1/2	A-1a	1	Input 1 Output 1		A1	
Receptacles 3/4	A-1b	2	Input 1 Output 2		A1	
Receptacles 5/6	A-1c	3	Input 1 Output 3		A1	
Receptacles 7/8	A-1d	4	Input 1 Output 4		A1	
Receptacles 9/10	A-1e	5	Input 2 Output 5		A2	
Receptacles 11/12	A-1f	6	Input 2 Output 6		A2	
Receptacles 13/14	A-1g	7	Input 2 Output 7		A2	
Receptacles 15/16	A-1h	8	Input 2 Output 8		A2	
Receptacles 17/18	A-1i	9	Input 3 Output 9		B1	
Receptacles 19/20	A-1j	10	Input 3 Output 10		B1	
Receptacles 21/22	A-1k	11	Input 3 Output 11		B1	
Receptacles 23/24	A-1l	12	Input 3 Output 12		B1	
Pole Light	A-2	13		SW1		L1
North Wall Lights (Wall Pack)	A-3	14		SW1		L2
South Wall Lights (Wall Pack)	A-4	15		SW1		L3
Receptacles 25/26	A-1m	16	Input 4 Output 13		B2	
Receptacles 27/28	A-1n	17	Input 4 Output 14		B2	
Receptacles 29/30	A-1o	18	Input 4 Output 15		B2	
Receptacles 31/32	A-1p	19	Input 4 Output 16		B2	
Spare		20				
Spare		21				
Spare		22				
Spare		23				
Spare		24				

External Overrides

EXTERNAL OVERRIDES

Using the External Override Inputs, you can connect an external override circuit to the controller.

You can utilize two types of overrides:

- A . A remote switch, like the Douglas 8501, that will turn the lighting output relays ALL ON or ALL OFF;
- B. Contact switches that can turn parking receptacle relays ON, ALL OFF or to 50% ON mode. These switches are usually controlled by an Energy Management System.

To override the Lighting Output Relays:

1. Connect a Douglas 8501 switch to the white lead of the power source and to the (External Override) INP terminal on the Controller.
2. Connect the (External Override) RTN terminal on the Controller to the blue lead of the power source.
3. Go the *SETUP>INPUT OPTIONS* Menu option of the Controller and select *LIGHTING*. (See page 10 of this manual for details.)

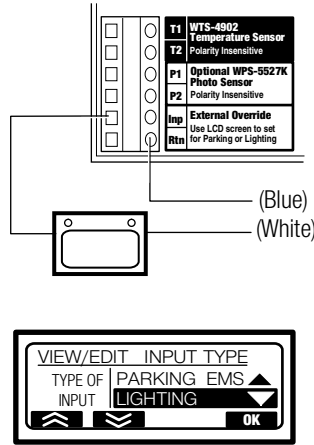

You connect the switch(es) to the White lead from the power source and the IN terminal of the Controller's EXTERNAL OVERRIDE input. The RTN terminal of the External Override is connected to the Blue lead from the same power source.

For stand-alone panel installations, connect to the WH and BLU terminals of the Controller's POWER output, which are supplied by the transformer. For multiple panel installations where the input switches are powered by an external power source, make sure the RTN connects to the same power source as the override switch(es).

To override the Parking Receptacle Relays:

1. Connect a Douglas 8501 switch to the white lead of the power source and to the (External Override) INP terminal on the Controller.
2. Connect the (External Override) RTN terminal on the Controller to the blue lead of the power source.

Be sure that the RTN terminal and the switches are connected to the same power source and that the switches are also properly connected to the Energy Management System, if used.

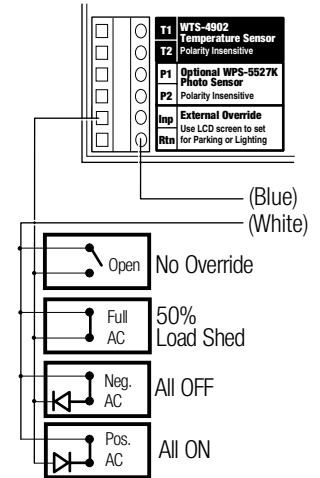

3. Go the *SETUP>INPUT OPTIONS* Menu option of the Controller and select *PARKING EMS*. (See page 10 of this manual for details.)



WTT-4944 Troubleshooting Guide

General Guidelines:

- Make sure that 24V power exists (always measure between 22VAC and 30VAC).
- Make input sensors are properly mounted. The Temperature Sensor must be mounted outside with no heat-emitting devices nearby. The Photo Sensor should face North, and be mounted so that it is protected from snow, debris or ice build-up and has no light-emitting devices nearby.
- Make sure all inputs and outputs are tightly connected.
- If any relay scanners are used, make sure they are connected properly to the Controller and to the output relays and, if a Programmable Relay Scanner is used, make sure it is programmed properly.
- With outdoor panels, make sure a panel heater is used and connected properly.
- Make sure all output relays are switched by the correct Controller output and that no more than 4 output relays connect to any Controller output unless a scanner is used.
- Make sure that the correct time and date is set;
- Make sure that all configuration settings, including Summer Mode and Input Override, are correct.
- Make that all scheduled events are enabled and disabled properly and that no scheduled events contradict one another.

Problem Encountered	Possible Cause(s)	Corrective Action
Flashing output LED(s) on relay scanner	Defective output relay	- replace relay
	2 relays connected to same output with one relay ON and the other OFF	- reset relays - if either relay is in another output group, remove it from that group
	External AC current leaking into circuit	- check wiring
	Controller memory overload	- delete older events or unnecessary commands
Parking output relays not tripping properly	Improper input voltage (must be between 22V and 30VAC)	- check connections - check power source
	False temperature sensor readings	- check mounting of temperature sensor - check that no heat-emitting devices are near the temperature sensor - remove any snow, ice or debris build-up from sensor - check heater mounting, connection and configuration - check Summer Mode setting
	Relays receiving contradictory or inappropriate commands	- check that each relay is only in one group - check Duty Cycle programming
Lighting output relay(s) not tripping properly	Improper input voltage (must be between 22V and 30VAC)	- check connections - check power source
	False input readings	- check mounting of Photo Sensor; it should face North - check that no light-emitting devices are near the Photo Sensor - remove any snow, ice or debris build-up from sensor - check configuration of Lighting Output 4
	Relays receiving contradictory or inappropriate commands	- check that each relay is only in one group - check scheduling programming - check that Photo Settings is ON - check Photo Enable setpoints
Input override not working properly	Inappropriate configuration	- check Input Option setting - check EMS settings, if used - check that proper switch types are used
	Faulty or improper switch connection	- check connections - check that WR-8501 LED switch is used with lighting override or contact switches used with parking override

Appendix A: Parking Settings & Schedules

OUTPUT A1	
Relays	Remarks

OUTPUT A2	
Relays	Remarks

OUTPUT B1	
Relays	Remarks

OUTPUT B2	
Relays	Remarks

Date _____

Duty Cycle Time	Duty Cycle Setpoints
_____ minutes	25% _____
	50% _____
	75% _____
	100% _____

SCHEDULES		
Action	Time Initiated	Days of the Week

Appendix B: Lighting Schedules

Date _____

Output 1				
Relays	Remarks	Action	Time Initiated	Days of the Week
_____	_____	_____	_____	_____
_____	_____	_____	_____	_____
_____	_____	_____	_____	_____
_____	_____	_____	_____	_____
_____	_____	_____	_____	_____
_____	_____	_____	_____	_____
_____	_____	_____	_____	_____

Output 2				
Relays	Remarks	Action	Time Initiated	Days of the Week
_____	_____	_____	_____	_____
_____	_____	_____	_____	_____
_____	_____	_____	_____	_____
_____	_____	_____	_____	_____
_____	_____	_____	_____	_____
_____	_____	_____	_____	_____
_____	_____	_____	_____	_____
_____	_____	_____	_____	_____

Output 3				
Relays	Remarks	Action	Time Initiated	Days of the Week
_____	_____	_____	_____	_____
_____	_____	_____	_____	_____
_____	_____	_____	_____	_____
_____	_____	_____	_____	_____
_____	_____	_____	_____	_____
_____	_____	_____	_____	_____
_____	_____	_____	_____	_____
_____	_____	_____	_____	_____

Output 4				
Relays	Remarks	Action	Time Initiated	Days of the Week
_____	_____	_____	_____	_____
_____	_____	_____	_____	_____
_____	_____	_____	_____	_____
_____	_____	_____	_____	_____
_____	_____	_____	_____	_____
_____	_____	_____	_____	_____
_____	_____	_____	_____	_____
_____	_____	_____	_____	_____

DOUGLAS **lighting controls®**

www.DouglasLightingControls.com
4455 Juneau Street • Burnaby, B.C. • CANADA
phone: (604) 873-2797 • fax: (604) 873-6939

WARRANTY

DOUGLAS products are warranted for one year from the date of purchase by the consumer against defects due to materials and the company's workmanship only. The sole obligation hereunder shall be to repair, or at the company's option to replace, products as aforesaid, provided same are returned, upon authorization, 'Transportation Prepaid' to the company's Burnaby, CANADA office within the said period. Defects or failures due to improper or careless installation, storage or handling, or usage other than rated conditions, are specifically excluded from this warranty. No liability is accepted for return transportation charges following repair or replacement as aforesaid or for reinstallation costs. No other liability of any nature or kind, whether arising out of or from the use of the product, whether or not defective, is assumed.

DOUGLAS lighting controls reserves the right to cancel or change items shown in this publication without notice.